

## SVERKER 900 Relay and substation test system



- The toolbox for substation 3-phase testing
- Three currents and four voltages
- Stand-alone functionality
- Rugged and reliable for field use
- Generation of 900 V and 105 A in single phase mode
- Secondary and primary testing

### DESCRIPTION

The SVERKER 900 Relay and substation test system is the engineer's ultimate toolbox that addresses the increasing need for three-phase testing capability in electrical distribution substations, renewable power generation stations and industrial applications. The intuitive user interface is presented on the LCD touch screen. It has a powerful combination of current and voltage sources and a versatility of measurement possibilities.

The SVERKER 900 is specifically designed for basic, manual three-phase secondary testing of protection devices. In addition, various primary testing can be performed, since the current and voltage sources can be series- and/or parallel connected to allow for up to 105AAC or 900VAC output. All three current and four voltage sources can be individually adjusted with respect to amplitude, phase angle and frequency. The fourth voltage source allows for testing of numerical relays that needs a reference voltage simulating the busbar.

### APPLICATION

- Commissioning and maintenance of distributed and generator power Substation
- Protection relays
  - ▶ Electromechanical relays
  - ▶ Static relays
  - ▶ Numerical relays
  - ▶ Self-powered relays
- Plotting current transformer excitation curves
- Current and voltage transformer ratio tests
- Burden measurement for CT circuits
- Polarity (direction) tests
- Impedance measurement
- Primary injection in switchgear
  - ▶ Three phase
  - ▶ Single phase
- Checking SCADA annunciation and measurement values
- Wiring check
- Relays with current transformer-operated trip release unit

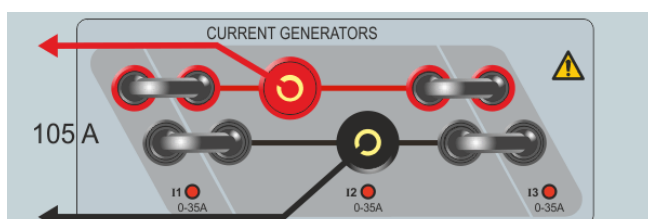

All three current generators in parallel.

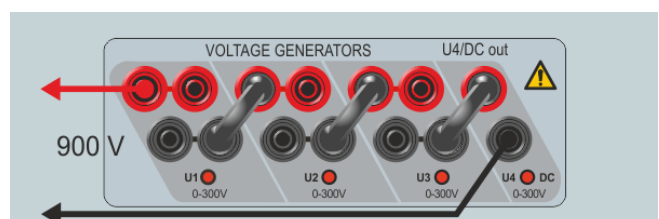

All four voltage generators in series.

## SVERKER 900 Relay and substation test system

### PANEL DESCRIPTION

- 1. BINARY INPUTS 1 – 4**  
The binary inputs are independently programmable gate circuits that permit simple selection of the desired mode for voltage or contact monitoring operation. Binary input 1 has a selectable threshold voltage.
- 2. EXTRA TIMER**  
The timer has separate start and stop inputs, and it can be used to measure both external cycles and sequences initiated by SVERKER. The measured time appears on the display. Each input can be set to respond to the presence or absence of voltage (AC or DC) at a contact.
- 3. BINARY OUTPUT**  
The binary output is used to simulate normally open/normally closed contacts for testing breaker failure schemes, or similar power system operations. In addition it may also be used to switch AC/DC voltages and currents.
- 4. A and V**  
Current and voltage are measured by the built-in ammeter and voltmeter. Resistance, impedance, phase angle, power and power factor can also be measured. Readings appear on the display. These instruments can also be used to take measurements in external circuits.
- 5. CURRENT GENERATORS**  
The current generators can be used separately, in parallel or in series.  
The current generators delivers maximum compliance voltage to the load constantly during the test, and range changing is done automatically, on-the-fly, under load.

- 6. VOLTAGE GENERATORS**  
The voltage generators can be used separately, in parallel or in series.
- 7. USB**  
For external keyboard, mouse, saving test data and for updating internal SW.
- 8. Mains inlet**
- 9. Ground (earth) connection**
- 10. On/Off switch**
- 11. Ethernet port**  
For authorized service actions
- 12. Touch screen**  
5.7" LCD touch screen
- 13. Control knob**  
For setting of current, voltage and other parameter values.

### FRONT HMI

The front HMI provide the user with a very simple way to manually or semi-automatic perform the tests, from making a simple primary injection in a switchgear to more complex secondary relay protection testing. The operation is simplified by use of a built-in computer operating system and touch screen.

The front HMI eliminates the need for a computer when testing virtually all types of relay or primary equipment in a substation. Intuitive menu screens and touch screen buttons are provided to quickly and easy select the desired test function. The front HMI includes non-volatile build in data storage for saving tests and test results. By using the USB port, test files/results could be transferred in between the SVERKER 900 and a PC. Test files are saved in csv format for use with Excel<sup>®</sup> to create reports.

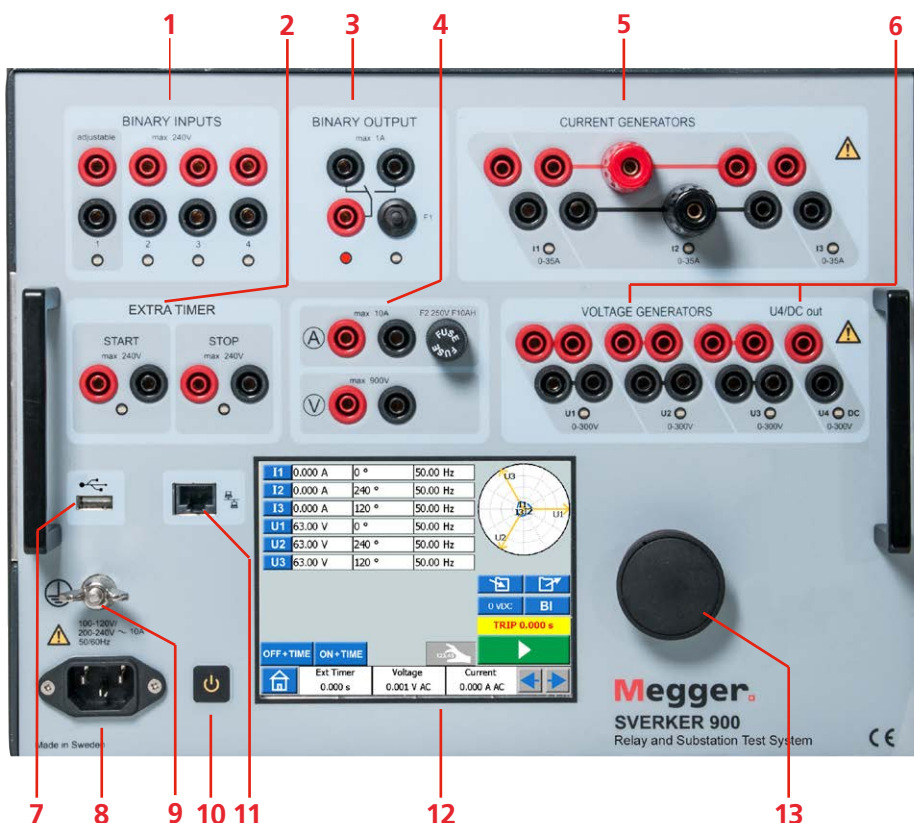

All outputs are independent from sudden changes in mains voltage and frequency, and are regulated so changes in load impedance do not affect the output. All current and voltage sources/generators are galvanically separated from each other and from ground. All outputs provide variable frequency.

## SVERKER 900 Relay and substation test system

### TEST INSTRUMENTS

SVERKER 900 contains a range of test instrument to be used depending of what kind of test to perform. Using the different test instruments you can set the output for the voltage and current generators, but also control them with the control knob.

#### Main instrument

- Timing test
- Manual determine the pick-up and drop-out of relay contact.
- General: set - inject - measure
- Multiple Timing Test (MTT)  
To test and verify currents with different amplitudes applied and to measure corresponding tripping times.
- Continuous current mode  
To be used in tests when the current circuit is interrupted repeated times.

#### CT Magnetization instrument

- Test to determine the knee point voltage of the current transformer.

#### Prefault – Fault instrument

- Timing test - to be used mainly to test relay which require a simulation of a prefault state before the fault simulation.
- Multiple Timing Test (MTT) with reference curve (IDMT) Inverse Definite Minimum Time.  
To test and verify currents with different amplitudes applied and to measure corresponding tripping times.
- Reference curves according to IEC60255-151:2009 "Functional requirements for over/under current protection".

#### Ramping instrument

- Automatic determine the pickup threshold
- Time testing, e.g. when testing df/dt relays
- Frequency ramp according to IEC 60255-181:2019 "Functional requirements for frequency protection".

#### Sequence instrument

- Simulation of sequences e.g. auto recloser, motor starts, re-striking earth fault.

#### Impedance instrument

- The impedance screen allows to test relays directly from the so called impedance plane, where the conversion from the impedance into voltages and currents is automatically done by SVERKER 900.
- Prefault and fault test
- Impedance ramping

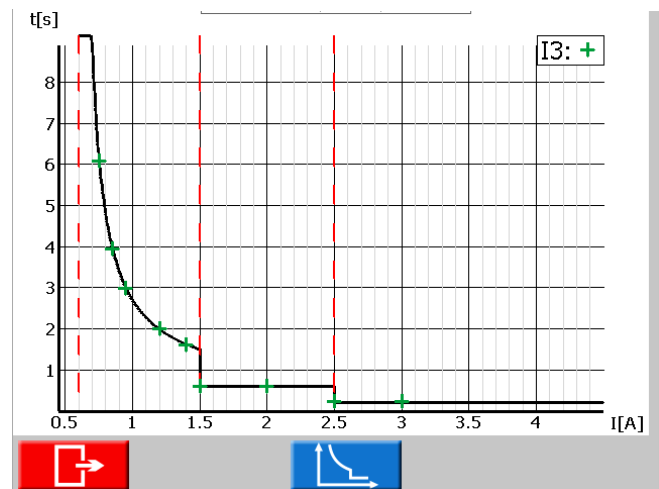

MTT in Prefault-Fault instrument with reference curve.

I1	0.000 A	0 °	50.00 Hz
I2	0.000 A	240 °	50.00 Hz
I3	0.000 A	120 °	50.00 Hz
U1	63.00 V	0 °	50.00 Hz
U2	63.00 V	240 °	50.00 Hz
U3	63.00 V	120 °	50.00 Hz

0 VDC    BI

**TRIP 0.000 s**

OFF + TIME    ON + TIME

123.45

Ext Timer    Voltage    Current

0.000 s    0.001 V AC    0.000 A AC

From the Main instrument you easily run the general tests.

I [A]	U [V]
0.037	30.05
0.026	29.21
0.022	28.34
0.018	26.97
0.016	24.88
0.014	21.09

30V    AUTO

0.2A

Ext Timer    Voltage    Current

0.000 s    0.000 VAC    0.000 AAC

Run the CT Magnetization instrument in auto or manual mode.

## SVERKER 900 Relay and substation test system

### PROTECTIVE RELAY TESTING

SVERKER 900 is performing a wide area for manual secondary testing of protective relay equipment. Virtually all types of single-phase and three-phase protection can be tested, from modern multifunction relays to electromechanical relays. It can inject current up to 105A when high range is needed and it has a frequency range from 10Hz up to 600Hz and also DC could be utilized. In the "expert mode" the user have the possibility to add layers of superimposed frequency. The rugged hardware design is built for field use over a wide temperature range, with intelligent software to perform rapid testing.

### APPLICATION EXAMPLE

#### IMPORTANT!

**Read the User's manual before using the instrument.**

The connection shows a general configuration that applies to most types of relay testing.

### Examples of what SVERKER 900 can test

Examples of what SVERKER 900 can test	ANSI® No.
Distance protection / under impedance relay	21
Overfluxing relays	24
Synchronising or synchronism-check relays	25
Undervoltage relays	27
Directional Power relays	32
Undercurrent or underpower relays	37
Loss of field relays	40
Negative sequence overcurrent relays	46
Phase sequence voltage relays	47
Thermal relays	49
Overcurrent- / ground fault relays	50 (N)
Inverse time overcurrent- / ground fault relays	51 (N)
Power factor relays	55
Overvoltage relays	59
Voltage or current balance relays	60
Directional overcurrent relays / ground fault relay	67 (N)
Motor overload protection	66
DC overcurrent relays	76
Phase-angle measuring or out-of-step protection relays	78
Automatic reclosing devices	79
Frequency relays	81
Carrier or pilot wire	85
Differential protection relays (differential circuits)	87
Directional voltage relays	91
Voltage and power directional relays	92
Tripping relays	94

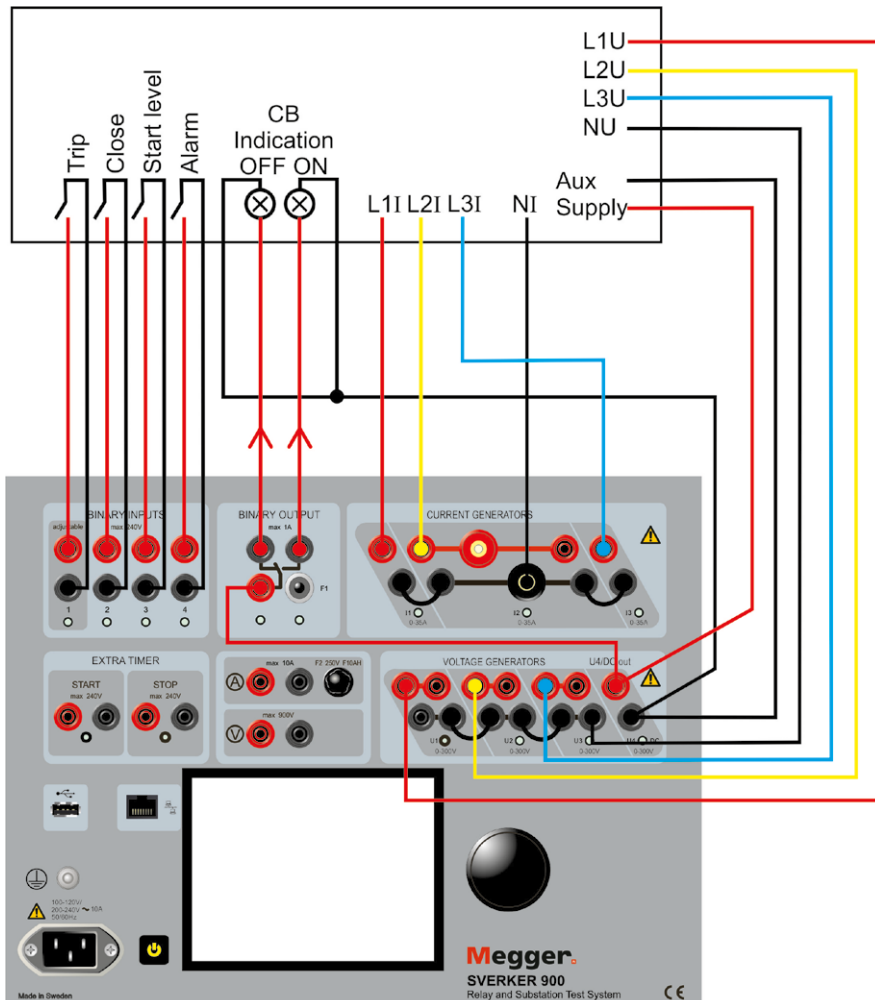

## SVERKER 900

### Relay and substation test system

#### SPECIFICATIONS SVERKER 900

Specifications are valid for resistive load, at 170-240 voltage supply and ambient temperature +25°C ±3°C, (77°F ±5.4°F) after 30 minutes warm up time and in the frequency range 15 Hz to 70 Hz.

All hardware data are for full scale values.

Specifications are subject to change without notice.

#### Environment

**Application field** For use in high-voltage substations and industrial environments.

#### Temperature

**Operating** 0°C to +50°C (32°F to +122°F)

**Storage & transport** -40°C to +70°C (-40°F to +158°F)

**Humidity** 5% – 95% RH, non-condensing

**Altitude (operational)** 2000 m (6500 ft)

#### CE-marking

**LVD** 2014/35/EU

**EMC** 2014/30/EU

**RoHS** 2011/65/EU

#### Classifications and standards

**Shock and vibration** IEC 60068-2-27

**Vibration** IEC 60068-2-6

**Voltage frequency ramp** IEC 60255-181:2019

#### General

**Mains input** 100 - 240 V AC, 50 / 60 Hz

**Current consumption** 10 A (max)

**Power consumption** 1800 VA (max)

#### Dimensions

**Instrument** 350 x 270 x 220 mm (13.8" x 10.6" x 8.7")

**Flight case with wheels** 615 x 295 x 500 mm (24.2" x 11.6" x 19.7")

**Flight case** 620 x 295 x 365 mm (24.4" x 11.6" x 14.4")

**Weight** 15.2 kg (33.5 lbs) Instrument only  
29.2 kg (64.4 lbs) with accessories and flight case (with wheels, GD-00185)  
24.1 kg (53.1 lbs) with accessories and flight case (GD-00182)

**Display** 5.7" LCD Touch screen

**Available languages** Czech, English, French, German, Spanish, Swedish

#### Measurement section

#### BINARY INPUTS 1, 2, 3, 4 and EXTERNAL TIMER

#### Start/Stop

**Number** 6

**Type** Dry or wet contacts max, 240VAC or 340VDC

**Galvanic Isolation** Galvanically separated

**Max measuring time** 35 minutes

**Debounce filter** Settable, 0 to 999 ms

**BINARY INPUT 1** Adjustable threshold and hysteresis

#### Timer

Range	Inaccuracy
0 – 50 ms	≤ 1 ms
50 – 500 ms	≤ 2 ms
> 500 ms	≤ 1%

**Resolution** 1 ms

#### Voltmeter

**Measurement method:** AC true RMS, DC mean value

**Insulation** 900 V, 1273 Vpeak

**Input rating** 900 V

#### Inaccuracy

##### Ranges DC

0-1 V ±0.5% of reading + 3 mV

0-10 V ±0.5% of reading + 7 mV

0-100 V ±0.5% of reading + 30 mV

0-900 V ±0.5% of reading + 300 mV

##### Ranges AC

0-1 V ±1% of reading + 5 mV

0-10 V ±1% of reading + 10 mV

0-100 V ±1% of reading + 50 mV

0-900 V ±1% of reading + 300 mV

#### Resolution

1 mV

#### Frequency

**Range** 10 Hz – 600 Hz

**Inaccuracy** < 0.01%

**Resolution** < 10 mHz

#### Ammeter

**Measurement method:** AC true RMS, DC mean value

#### Inaccuracy

##### Ranges DC

0-200 mA ±0.5% of reading + 2 mA

0-1.5 A ±0.5% of reading + 3 mA

0-10 A ±0.5% of reading + 10 mA

##### Ranges AC

0-200 mA ±1% of reading + 2 mA

0-1.5 A ±1% of reading + 3 mA

0-10 A ±1% of reading + 20 mA

#### Resolution

0.1 mA

#### Frequency

**Range** 10 Hz – 600 Hz

**Inaccuracy** < 0.01%

**Resolution** < 10 mHz

#### Extra measurements

#### Power factor and phase angle measurements

	Ranges	Resolution	Inaccuracy
<b>Power factor cosφ</b>	-0.01 (cap) to 1 to +0.01 (ind)	< 0.01	<0.04
<b>Phase angle (°) <sup>1)</sup></b>	0° - 360°	<0.1°	<0.8°

#### Impedance and power measurement

**AC** Z(Ω), R(Ω), X(Ω), P(W), S(VA), Q(VAR)

**DC** R(Ω), P(W)

**Range** Up to 999 kX (X=unit)

1) Valid with current >1 A and voltage >10 V

#### BINARY OUTPUTS

**Insulation** 250 V AC

**Current** 1 A (max)

**Voltage** 250 V AC or 120 V DC



# SVERKER 900

## Relay and substation test system

### Generation section

#### Voltage generators

Voltage outputs U1, U2, U3 and U4/DC out  
 All voltage sources/generators are galvanically separated from each other and from ground.  
 Floating common return is made by using jumper connectors

#### Range

4-phase AC 4 x 300 V  
 4-channel DC 4 x 300 V

#### Power

4-phase AC 4 x 125 VA (max)  
 4-channel DC 4 x 125 W (max)

#### Inaccuracy AC

Typical 0.03% of reading + 0.01% of range  
 Guaranteed 0.05% of reading + 0.03% of range

#### Distortion(THD+N)<sup>1)</sup>

< 0.14% typical (0.25% max)

#### Resolution

10 mV

#### Phase

Angle range 0° - 360°  
 Inaccuracy <sup>2)</sup> < 0.5° (at 50 and 60 Hz)  
 Resolution 0.1°

#### Frequency

Range 10 Hz - 600 Hz  
 Inaccuracy <sup>2)</sup> < 0.03 % (45 Hz - 66 Hz)  
 Resolution 1 mHz

- 1) THD+N: Values at 50/60 Hz, 200-300 V, ≥1500 Ω load. Measurement band with 22 Hz–22 kHz.  
 2) The specification is valid for resistive load >2000 Ω for voltage output separately U1, U2, U3 and U4/DC out.

Voltage generators in single-phase mode, AC or DC			
4 Voltage generators in parallel: U1 // U2 // U3 // U4	Voltage	Power (max)	Current (max)
	300 V	375 VA	1.2 A
	100 V	300 VA	3.0 A
	67 V	300 VA	4.5 A
External load: min 7 Ω			
3 Voltage generators in parallel: U1 // U2 // U3	Voltage	Power (max)	Current (max)
	300 V	312 VA	1.0 A
	100 V	250 VA	2.5 A
	67 V	250 VA	3.7 A
External load: min 9 Ω			
4 Voltage generators in series: U1 – U2 – U3 – U4	Voltage	Power (max)	Current (max)
	900 V	450 VA	0.5 A
	400 V	360 VA	0.9 A
	268 V	350 VA	1.3 A
External load: min 100 Ω			
3 Voltage generators in series: U1 – U2 – U3	Voltage	Power (max)	Current (max)
	900 V	350 VA	0.4 A
	300 V	280 VA	0.9 A
	200 V	275 VA	1.4 A
External load: min 75 Ω			

#### Current generators

Current outputs I1, I2 and I3  
 All current generators are galvanically separated from each other and from ground  
 Floating common return, is made by using jumper connectors

#### Range

3-phase AC 3 x 35 A  
 At least 15 repetitions: 10 s ON and 20 s OFF

3-phase DC 3 x 35 A  
 At least 15 repetitions: 10 s ON and 20 s OFF

3-phase AC 3 x 20 A continuous

3-phase DC 3 x 20 A continuous

#### Power

3-phase AC (max) 3 x 277 VA

3-phase DC (max) 3 x 275 W

#### Inaccuracy AC

	Range	Error
Typical	<200 mA	<0.5 mA
	200 mA to 35 A	0.1% of reading+0.01% of range
Guaranteed	<200 mA	<3 mA
	200 mA to 35 A	0.4% of reading+0.01% of range

Distortion(THD+N)<sup>4)</sup> < 0.10% typical (0.20% max)

Resolution 1 mA

Compliance voltage ≤50 Vrms

#### Phase

Angle range 0° - 360°  
 Inaccuracy <sup>5)</sup> < 0.2° (at 50 and 60 Hz)  
 Resolution 0.1°

#### Frequency

Range 10 Hz - 600 Hz  
 Inaccuracy <sup>5)</sup> < 0.03 % (45 – 66 Hz)  
 Resolution 1 mHz

- 4) THD+N: Values at 50/60 Hz, 1-5 A, 0.5 VA load. Measurement band with 22 Hz–22 kHz.  
 5) The specification is valid for resistive load ≤0.08 Ω and I ≥0.15 A.

Current generators in single-phase mode, AC			
Current generators in parallel: I1 // I2 // I3			
Current	Power (max)	Voltage (max)	Duty cycle
2.6 A	198 VA	76 V	Continuous
16 A	816 VA	51 V	Continuous
26.5 A	827 VA	31.2 V	Continuous
45.5 A	819 VA	18 V	Continuous
60 A	800 VA	14 V	Continuous
105 A	721 VA	7 V	At least 15 repetitions: 10 s ON and 20 s OFF
Current generators in series: I1 – I2 – I3 <sup>6)</sup>			
Current	Power (max)	Voltage (max)	Duty cycle
2.5 A	403 VA	161 V	Continuous
8.2 A	860 VA	105 V	Continuous
17.6 A	827 VA	47 V	Continuous

6) Max 18 A and 70 Hz

## SVERKER 900 Relay and substation test system

### Optional accessories

#### Low current adapters LCA1 and LCA2

##### Dimensions

LCA1 110 x 64 x 28 mm (4.3" x 2.5" x 1.1")

LCA2 110 x 64 x 44 mm (4.3" x 2.5" x 1.7")

**Weight (LCA1+LCA2)** 0.4 kg (0.9 lbs)

**Input** 5 A (max)

### OPTIONAL ACCESSORIES

#### SVERKER Viewer

PC software which can create graphical test reports in pdf format. The pdf test report is created by opening a saved test file, on a USB stick, from SVERKER 900.

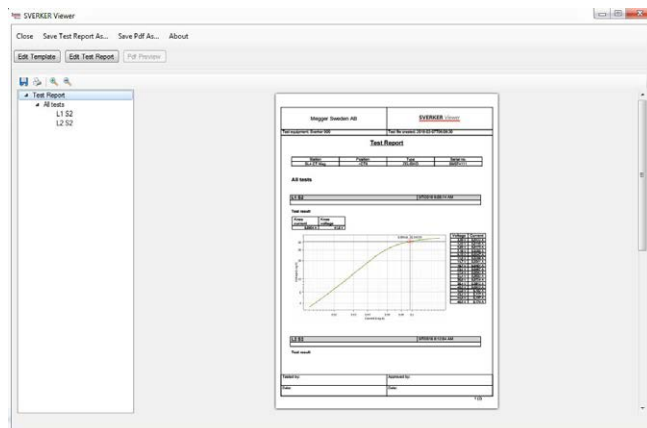

Pdf test report from determine the knee point voltage of the current transformer.



Flight case (GD-00182)



Low current adapters (CR-90010)

For generation of low currents (0–30 mA) when testing protection such as sensitive earth fault, capacitor unbalance and reverse power protection.

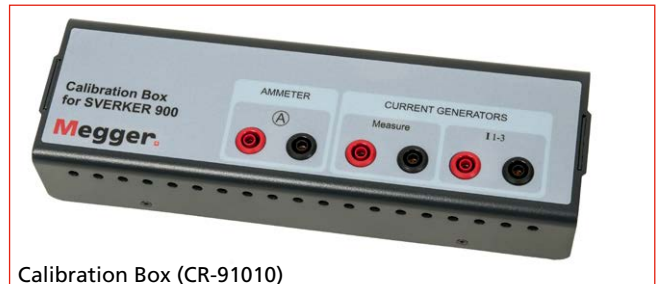

Calibration Box (CR-91010)

To make a calibration a digital multimeter with high accuracy is also needed, e.g. the KEYSIGHT 34479A or equivalent.

Megger Sweden AB		SVERKER Viewer	
Test equipment: Sverker 900		Test file created: 2018-03-19T09:21:12	
Test Report			
Station	Position	Type	Serial no.
SL4 MTT Danderyd	+HL77	REXS21	557799
All tests			
IL1 > and >>		3/19/2018 9:24:39 AM	
Test result			
#	I [A]	Time	
1	1.2 A	3783 ms	
2	1.35 A	2314 ms	
3	1.5 A	1723 ms	
4	1.8 A	1201 ms	
5	2.1 A	985 ms	
6	2.2 A	326 ms	
7	2.6 A	318 ms	
8	3 A	322 ms	
Tested by:		Approved by:	
Date:		Date:	

PDF report from a timing test of overcurrent protection.

## INCLUDED ACCESSORIES

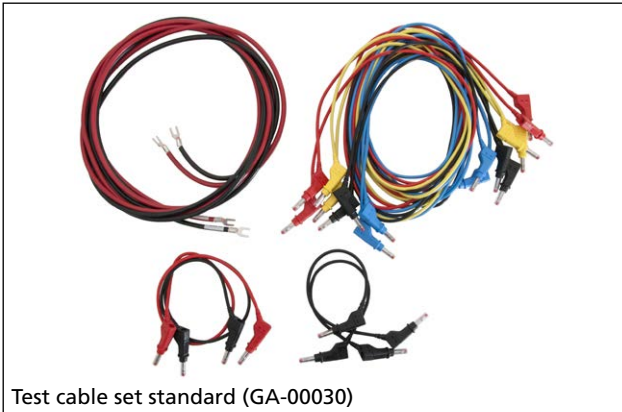

Test cable set standard (GA-00030)



Earth (ground) cable (GA-00200)

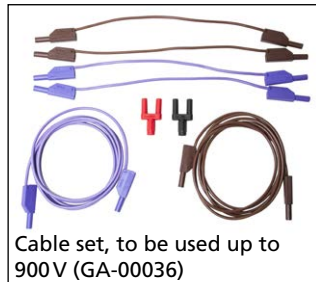

Cable set, to be used up to 900 V (GA-00036)



Flight case with wheels (GD-00185)



Inside the lid are ten jumpers "parked" in holders, a touch screen, a pen and the quick guide.



Soft case Combi (GD-00900)

### Postal address

Megger Sweden AB  
Box 724  
SE-182 17 Danderyd  
SWEDEN

T +46 8 510 195 00  
E seinfo@megger.com

### SVERKER-900\_DS\_en\_V17

ZI-CR01E • Doc. CR0271RE • 2022  
Subject to change without notice  
Megger Sweden AB  
Registered to ISO 9001 and 14001  
The word 'Megger' is a registered trademark

www.megger.com

## ORDERING INFORMATION

Item	Cat. No.
SVERKER 900 Basic	CR-19090
SVERKER 900 Standard	CR-19092
SVERKER 900 Expert	CR-19094
SVERKER 900 Standard with soft case (2)	CR-19192

### Instrument configuration table

Instrument	Basic	Standard	Expert
Main Prefault - Fault	X	X	X
Ramping Sequencer CT Magnetization		X	X
Impedance			X
Prefault - Fault with MTT		X	X
Prefault - Fault with MTT and reference curves		X <sup>1)</sup>	X <sup>1)</sup>

1) Requires SVERKER Viewer Licence

### Included accessories for all above

Test cable set standard	GA-00030
Earth (ground) cable	GA-00200
Cable set 900 V	GA-00036
Flight case with wheels	GD-00185
2) Flight case is change to soft case	

### Optional accessories

SVERKER Viewer PC Software	CR-8101X
----------------------------	----------

When ordering to an existing SVERKER 900, Please specify the serial number.

The license key is individually related to the serial number of the SVERKER 900. The test files need to be licensed to be able to open with SVERKERViewer. The SVERKER Viewer software itself, can be installed on unlimited number of PC's.

Flight case	GD-00182
Soft case Combi	GD-00900
Low current adapter	CR-90010
Calibration box	CR-91010

**Megger**<sup>®</sup>